

R19IT3S-MLA3FP

19" Intel® Core™ i5-1135G7 Defence Console Rack Panel PC

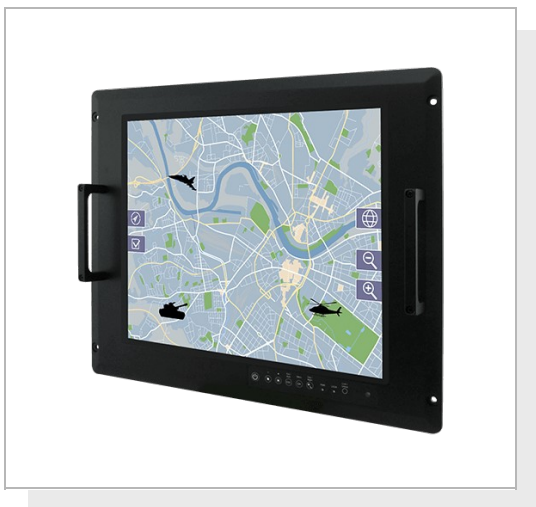

KEY FEATURES

- Intel® Core™ i5-1135G7 2.4 GHz (turbo to 4.2GHz) Processor
- Anti-Corrosion Housing / Fanless
- Projective Touch
- Compliant with MIL-STD-810G/F , MIL-STD-461E/F
- Flush Rack / Rack Mount Mechanical Design (8U)
- Convenient On-Screen Display Controls
- AC 110~240 V Power input default
- Isolation DC 9~36 V Power input (Optional)
- Built-in Light Sensor for auto brightness control



SPECIFICATIONS

Display	
Resolution	1280x1024
Contrast Ratio	1000:1
View Angles	85,85,80,80
Touch / Glass	Projected Capacitive Multi Touch Screen PCAP with With ITO Flim (Optional)
Size	19 inches
Panel Brightness	350 nits
Active Area	376.32x301.06 mm
System Specification	
Processor	Intel Core i5-1135G7 2.4GHz (up to 4.2GHz) Intel Core i5-1145G7 2.6GHz (up to 4.4GHz) (Optional)
Memory	1 x SO-DIMM, DDR4 3200 MHz, 4GB 8GB (Optional) 16GB (Optional) 32GB (Optional)
Storage	1 x M.2 M-Key 2242 SATA SSD or 1 x M.2 M-Key 2280 NVMe SSD 128GB 256GB (Optional) 512GB (Optional) 1TB(for NVMe) (Optional) 2TB(for NVMe) (Optional) 4TB(for NVMe) (Optional) 1 x SATA III , up to 2TB (Optional)
Ethernet controller	2 x Intel® Ethernet Controller
Security	TPM 2.0
Operating System	Windows 11 IoT Enterprise SAC (64 bit) (Optional) Windows 10 IoT Enterprise (64 bit) (Optional) Linux Ubuntu 22.04 (Optional)
Environment	
Operating Humidity	10% to 95% RH
Storage Temperature	-30°C~70°C
Operating Temperature	-20°C~60°C
Compliance	
MIL-STD 461E/F	RE101 / RE102 CE101 / CE102 with EMI Glass / Touch(Optional) RS101 / RS 103 CS101 / CS 106 / CS 109 / CS 114 / CS 115 / CS 116
MIL-STD 810F/G	Vibration Method 514.5 Humidity Method 507.4 Transit Drop Method516.5
Certification	

Certification	CE, FCC		
Accessory	1 x Manual(Hardcopy) 1 x Driver CD 1 x Power Cord (MIL-DTL-38999/1)		
Mechanical			
Dimension	482.6 x 399.3 x 79.6 mm	Mounting	Rack Mount/ VESA Mount
Enclosure	Metal Housing with Aluminum Bezel	Cooling System	Fanless Design
IO Ports			
USB Port	2 x USB 3.2 Gen 1	Serial Port	1 x RS232(Default)/422/485
Video	1 x HDMI (Optional)	LAN	2 x RJ-45
Power			
Power Rating	AC 100~240V, Universal, ±10% DC 9~36V, ±10% (Optional)		
Control			
Button	8 Key OSD Control Pad: Power, Brightness DOWN, Brightness UP, Night, Day, Auto / Manual, Reset, Lock		

DIMENSIONS UNIT:MM

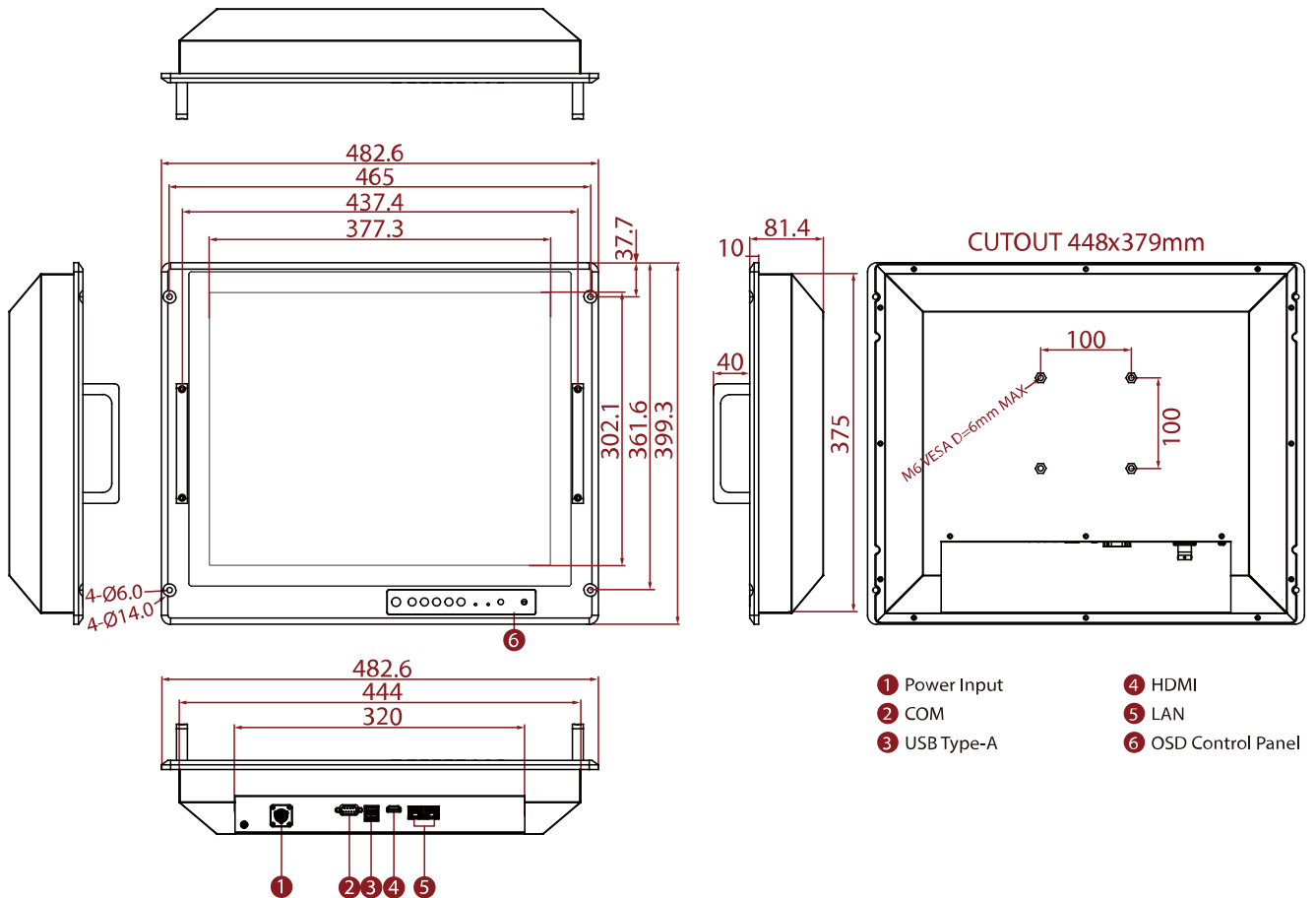

NOTE

1. This is a simplified drawing and some components are not marked in detail.
2. Please contact our sales representative if you need further product information.
3. All specifications are subject to change without prior notice.
4. The product shown in this datasheet is a standard model. For diagrams that contain customized or optional I/O, please contact the Winmate Sales Team for more information.